



# **INNOMAG<sup>®</sup> TB-MAG<sup>™</sup>**

## **Thrust-balanced, Fluoropolymer-lined, Magnetic Drive Pump**

ASME B73.3 • ISO 2858



*Experience In Motion*

## Advanced sealless pump technology

The INNOMAG TB-MAG pump sets a new benchmark for magnetic drive pump value and performance. This versatile pump is engineered to provide low total cost of ownership and exceptional leakage protection in extremely corrosive and environmentally critical applications.

While the TB-MAG pump boasts many innovative design elements, the key to its proven performance is its revolutionary dynamic thrust balancing system. This cleverly engineered system eliminates the need for thrust bearings and results in highly efficient operation with outstanding reliability, even in applications containing solids.



### **INNOMAG TB-MAG**

*Thrust-balanced, fluoropolymer-lined,  
magnetic drive pump*

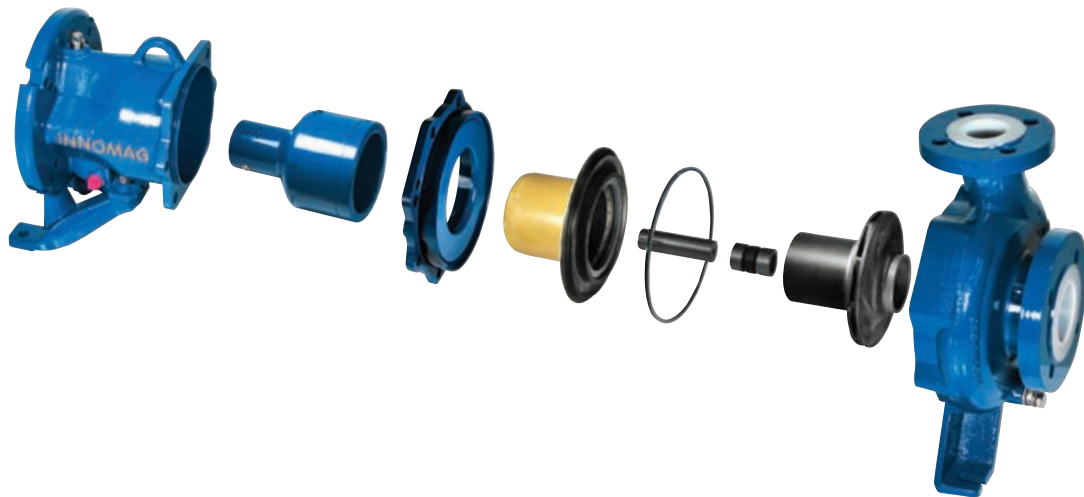

## Engineered for better performance

- Efficient performance over the entire flow range is achieved by means of a dynamic thrust balancing system.
- Back wear rings offer superior solids handling capability by restricting solids larger than 0.127 mm (0.005 in) from entering the containment shell. Effectively, only clean process fluid reaches the shaft and bearings for proper cooling and lubrication.
- Double-sealed inner magnet assembly uses a hermetically sealed stainless steel sheath to protect the magnets from corrosive permeation.
- Rotomolded ETFE liner provides a mechanical bond with the casing and is rated for full vacuum. The rotomolding process enables the use of advanced volute geometries for higher efficiencies.

## Operating parameters

- Flows to 360 m<sup>3</sup>/h (1,585 gpm)
- Heads to 153 m (500 ft)
- Pressures to 25 bar (362 psi)
- Temperatures from -29°C to 120°C (-20°F to 250°F)
- Solids to 30% by volume; spherical size to 6.35 mm (0.25 in)

## Typical applications

- Chemical processing
- Reactor feed
- Chlor-alkali
- Chemical waste treatment
- Scrubber systems
- Tank car loading/unloading
- Metal finishing (pickling)
- Etching and plating





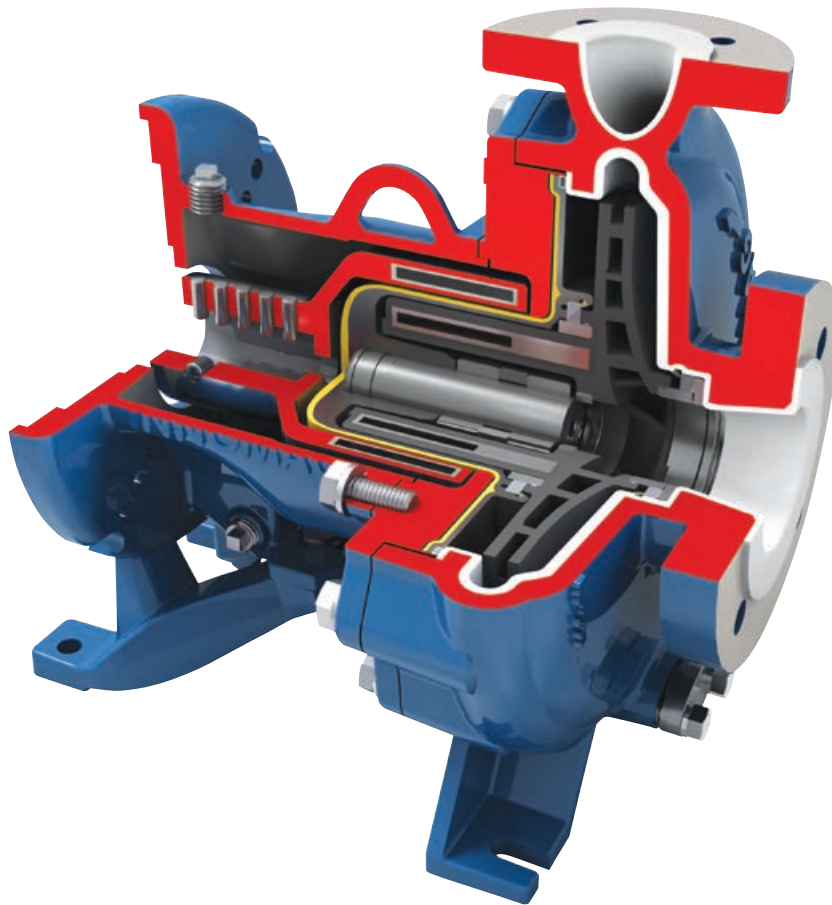

Compliant with ASME B73.3 or ISO 2858/15783 standards, the TB-MAG pump incorporates many advanced features to enhance performance, safety and reliability. This versatile pump offers outstanding leakage protection for compliance with environmental regulations or “clean floor” initiatives. It has been engineered to provide low total cost of ownership in applications throughout the chemical processing, metals and other industries.

## Features and benefits

**Pure ETFE casing liner** is rotationally molded and vacuum rated. Liner has a minimum thickness of 3 mm (0.125 in). ASME B16.5 Class 150 or EN 1092-2 (ISO) PN 16 flanges standard; Class 300, ISO PN 25 and JIS 10K flanges are optional.

**One-piece ETFE impeller and inner magnet assembly** ensures maximum torque transmission, simplifies maintenance and eliminates balancing. Enclosed impeller with unobstructed eye delivers high efficiency and low NPSHR.

**Powerful neodymium iron boron (NdFeB) magnets** maximize torque transmission.

**Double-sealed inner magnets** offer unmatched resistance to corrosive permeation by sheathing the magnets in 316L stainless steel before they are injection molded into the impeller assembly.

**One-piece composite containment shell** consists of aramid and carbon fiber-reinforced ETFE for optimal leakage protection and corrosion resistance. A burst pressure exceeding 205 bar (3,000 psi) resists water hammer damage. Composite construction means zero eddy current losses for maximum efficiency.

**Sintered alpha silicon carbide pump shaft** is oversized to handle all radial loads. Stationary cantilevered design eliminates suction-blocking shaft supports to maximize flow and minimize NPSHR.

**Tandem sintered silicon carbide radial bearings** are process lubricated and separately mounted for optimal alignment with the shaft. Individually replaceable, they utilize a PTFE center spacer to maintain proper bearing position.

**IEC D-flange or NEMA C-face motor adapter** with integral foot mates to existing ISO or ASME (ANSI) baseplates.

**Parts interchangeability** among the available sizes reduces inventory costs and eases maintenance.

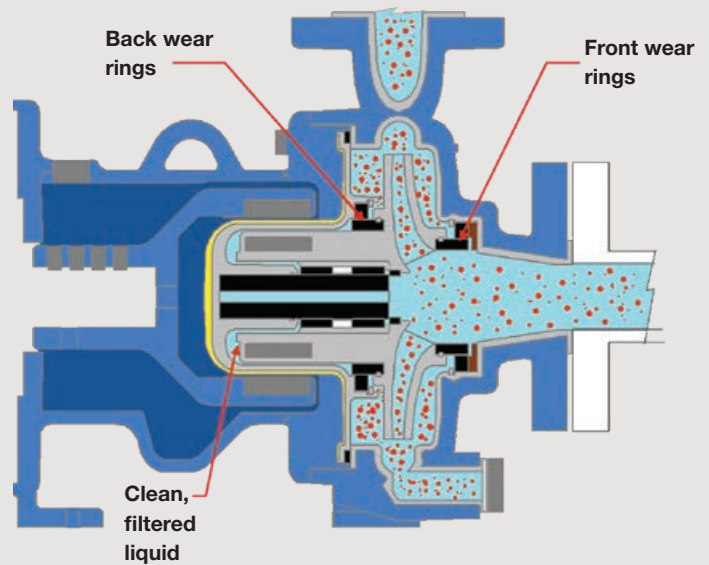

### Revolutionary thrust-balanced design

The INNOMAG TB-MAG pump employs a dynamic thrust balancing system that eliminates the need for thrust bearings. Pump reliability and longevity are increased over conventional net thrust forward designs. Pump efficiency is also improved, and operating costs reduced correspondingly.

#### Dynamic control

Effective over the entire pump operating range, the TB-MAG pump automatically responds to changes in flow, pressure or viscosity to balance axial thrust. Balance is achieved through the combined action of the back wear rings and a variable orifice created by the impeller assembly and the front of the shaft. The fixed clearance between the wear rings regulates the flow of fluid behind the impeller and into the balance chamber. The variable orifice governs the pressure in the balance chamber.

As operating conditions (and the associated axial thrust loads) change, the impeller assembly responds by moving axially. This movement increases or decreases the size of the variable orifice, causing pressure in the balance chamber to decrease or increase, in turn. The resulting change in balance chamber pressure automatically compensates for the change in operating conditions and maintains thrust balance.

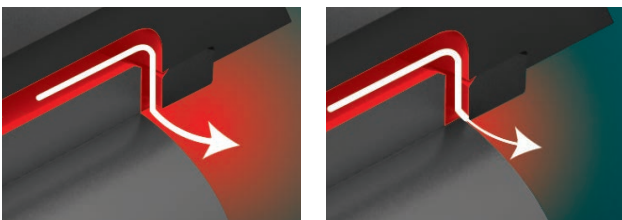

*The variable orifice opens and closes to dynamically control the balance chamber pressure.*

### Superior solids-handling capability

For magnetic drive pumps, solids can cause significant damage when in contact with the radial bearings, inner magnets and containment shell. The TB-MAG pump prevents this by using silicon carbide back wear rings to restrict solids larger than 0.127 mm (0.005 in) from entering the containment shell. Effectively, only clean liquid can reach the bearings and pump shaft.

### Trouble-free maintenance

The TB-MAG pump offers many features designed to expedite maintenance and keep associated costs low:

- Standard back pullout eases general maintenance and inspection. The casing stays in-line and the piping connections remain intact.
- Contained back pullout simplifies drive end maintenance. The process fluid remains fully confined, thereby eliminating the need to drain or purge the pump. Plus, maintenance personnel are kept safe from exposure to potentially harmful process fluids.
- Fully assembled replacement kits are available for all major components, including: impeller assemblies, containment shells and casings.
- All silicon carbide components, including rotating and stationary wear rings, are 100% replaceable.
- All mating and exposed metal surfaces are coated in a premium epoxy/epoxy polyamide primer and an aliphatic acrylic polyurethane top coat to resist atmospheric corrosion.

## Options and technical data



### Optional secondary containment

For the most demanding applications, such as  $TiCl_4$ , the INNOMAG TB-MAG pump may be specified with an available long-coupled bearing frame fitted with an off-the-shelf, cartridge-style, dry-running mechanical seal. This design provides for a secondary containment chamber and does not require gas or liquid seal flush lines.

### Available baseplates

A range of baseplates is available to meet application requirements with regards to rigidity, vibration dampening, corrosion resistance, etc.

- Standard foundation mounted C-channel
- Foundation or stilt mounted reinforced C-channel
- Foundation or stilt mounted polymer concrete

### Additional options and accessories

- Low-flow models
- Vertical in-line configurations for small floor space installations
- Long-coupled bearing frame
- Run-dry bearings
- Flanged casing drain
- Steam heat jackets
- Power monitors and temperature probes
- Priming tanks

### Standards compliance

The TB-MAG pump is CE marked and compliant with applicable directives such as ATEX.

### Materials of construction

Component	Material
Casing (armor/liner)	Ductile iron/ETFE
Thrust collar	Carbon fiber reinforced PTFE
Front wear rings (stationary and rotating)	Silicon carbide
Impeller magnet assembly	Carbon fiber reinforced ETFE
Back wear rings (stationary and rotating)	Silicon carbide
Thrust control ring	Silicon carbide
Shaft	Silicon carbide
Radial bearings	Silicon carbide
Bearing spacer	PTFE
Containment shell (liner/housing)	Carbon fiber reinforced ETFE/aramid vinyl ester
Outer magnet assembly (armor/magnets)	Ductile iron/NdFeB
Casing O-ring	FEP with FKM core
Containment ring	Ductile iron
Motor adapter	Ductile iron

## ASME sizes

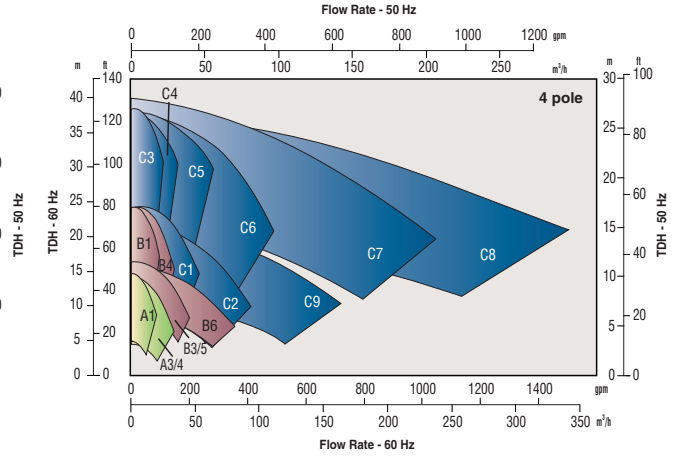
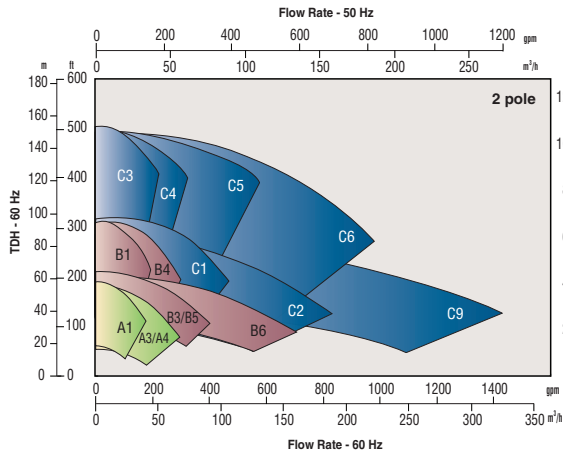

## Specialty sizes – low-flow and vertical

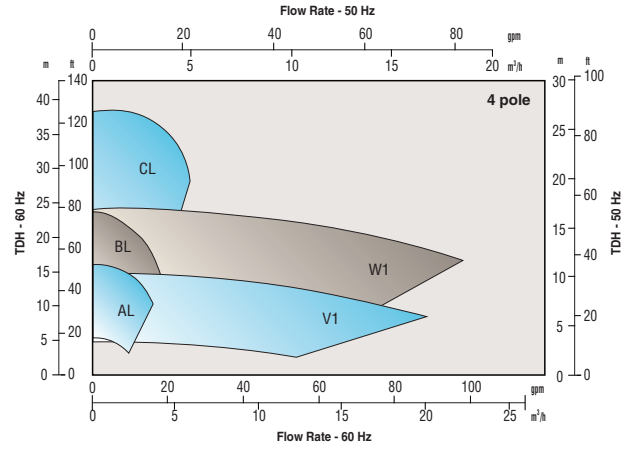
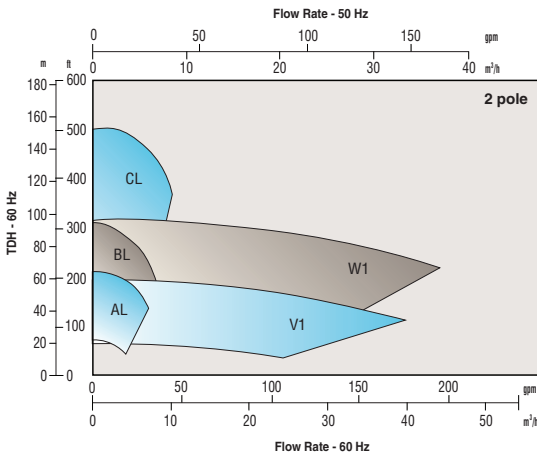

## ISO sizes

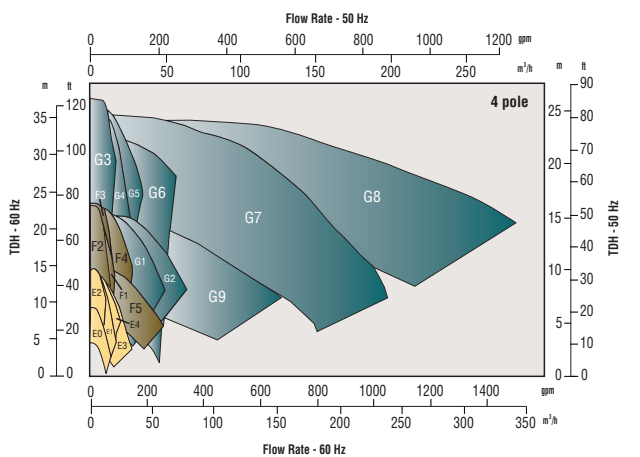
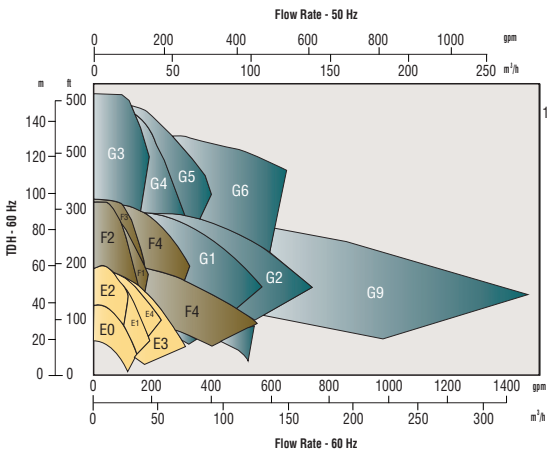

### ASME sizes

A1-1.5x1x6, A3-3x1.5x6, A4-3x2x6
B1-1.5x1x8, B3/B5-3x2x6, B4-3x1.5x8, B6-4x3x6
C1-3x2x8, C2-4x3x8, C3-2x1x10, C4-3x1.5x10, C5-3x2x10, C6-4x3x10, C7-4x3x10H, C8-6x4x10H, C9-6x4x8

### Specialty sizes

AL-1.5x1x6x6LF, V1-2x1.5x6
BL-1.5x1x8LF, W1-2x1.5x8
CL-2x1x10LF

### ISO sizes

E0-50x32x125B, E1-50x32x160A, EL/M/N-50x32x160L/M/N, E2-50x32x160B, E3-65x50x160A, E4-65x40x160B
F1-50x32x200A, FL/M/N-50x32x200L/M/N, F2-50x32x200B, F3-65x40x200B, F4-65x40x200A, F5-80x50x160B
G1-80x50x200B, G2-100x65x200B, G3-50x32x250B, G4-65x40x250B, G5-80x50x250B, G6-100x65x250B, G7-125x100x250B, G8-150x125x250B, G9-125x80x200B



Flowserve Corporation  
5215 North O'Connor Blvd.  
Suite 2300  
Irving, Texas 75039-5421 USA  
Telephone: +1 937 890 5839

**PUBR000126-06 (EN/A4)** February 2020

Flowserve Corporation has established industry leadership in the design and manufacture of its products. When properly selected, this Flowserve product is designed to perform its intended function safely during its useful life. However, the purchaser or user of Flowserve products should be aware that Flowserve products might be used in numerous applications under a wide variety of industrial service conditions. Although Flowserve can provide general guidelines, it cannot provide specific data and warnings for all possible applications. The purchaser/user must therefore assume the ultimate responsibility for the proper sizing and selection, installation, operation, and maintenance of Flowserve products. The purchaser/user should read and understand the Installation Instructions included with the product, and train its employees and contractors in the safe use of Flowserve products in connection with the specific application.

While the information and specifications contained in this literature are believed to be accurate, they are supplied for informative purposes only and should not be considered certified or as a guarantee of satisfactory results by reliance thereon. Nothing contained herein is to be construed as a warranty or guarantee, express or implied, regarding any matter with respect to this product. Because Flowserve is continually improving and upgrading its product design, the specifications, dimensions and information contained herein are subject to change without notice. Should any question arise concerning these provisions, the purchaser/user should contact Flowserve Corporation at any one of its worldwide operations or offices.

©2020 Flowserve Corporation. All rights reserved. This document contains registered and unregistered trademarks of Flowserve Corporation. Other company, product, or service names may be trademarks or service marks of their respective companies.